

### Hydraulic Performance Curves

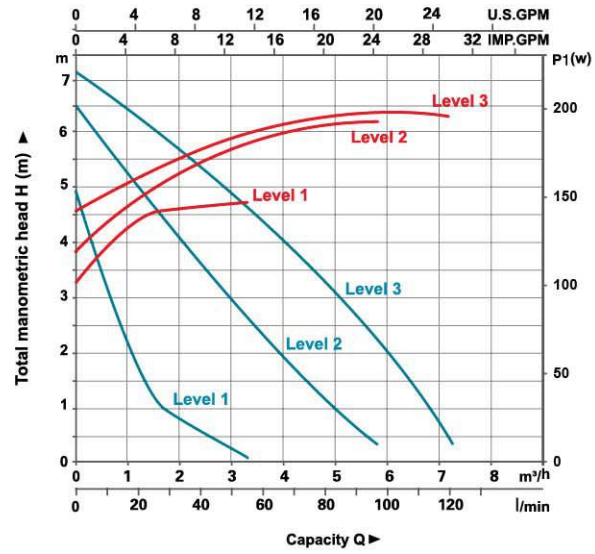

**LRP25-80/180**  
— Q-H  
— Q-P

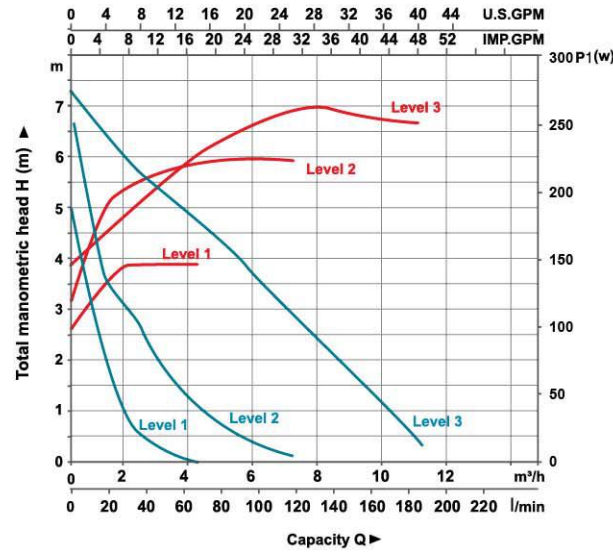

**LRP32-80/180**  
**LRP32-80F/220**  
**LRP36-80F/200**  
— Q-H  
— Q-P

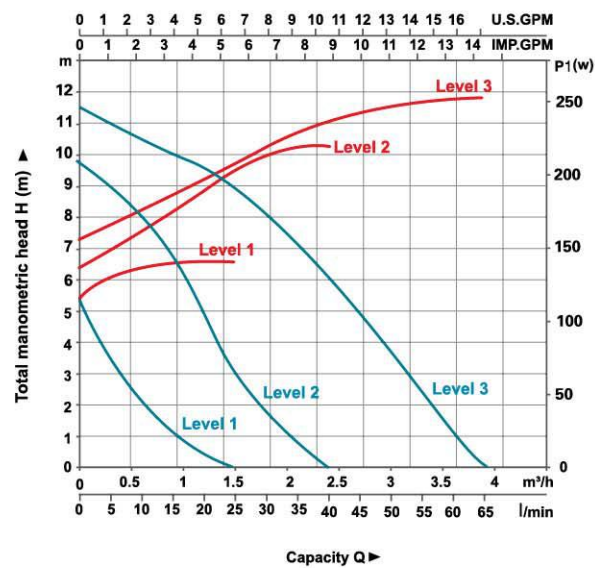

**LRP25-120/180**  
— Q-H  
— Q-P

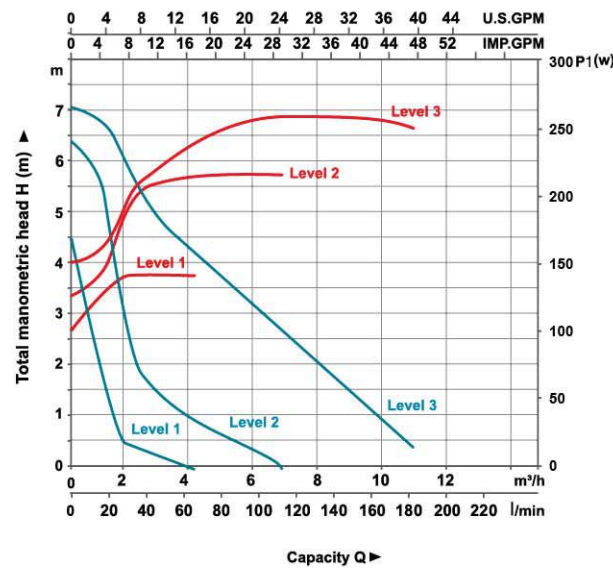

**LRP40-80F/250**  
— Q-H  
— Q-P

### Application

- Can be used to transfer clean water or other liquids similar to water in physical and chemical properties
- Heating systems with constant or variable flows
- Heating systems with variable flow-pipe temperature
- Heating systems where night setback is desired
- Heating systems where the differential pressure of the pump is too high during periods of reduced flow demand
- Heating systems where requires a fully automatic adjustment of the performance to flow demands
- Pressure boosting of water heaters
- Circulation and pressure boosting of domestic water

### Pump

- Compact design with perfect integrated control unit
- Anti-rust cast iron pump body
- Noryl impeller with heat resistant up to 150°C
- 99% alumina ceramic shaft
- Liquid temperature: 2°C to 110°C

### Motor

- Insulation class: H
- Protection class: IP42
- 99% alumina ceramic bearing
- Copper winding
- Power /frequency(V/Hz): 220-240/50
- EEI: ≤ 0.23, which complies with the Eup Directive



Connectors on request



### Identification Codes

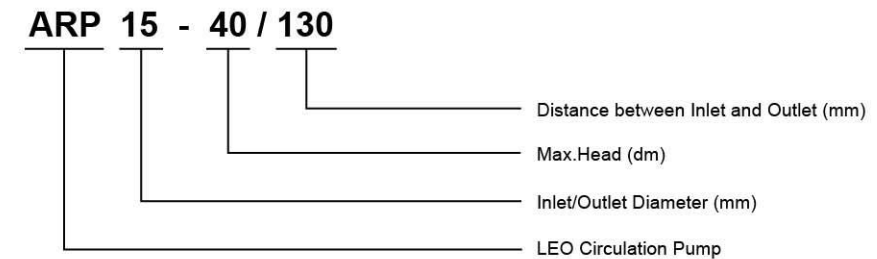

Function Introduction

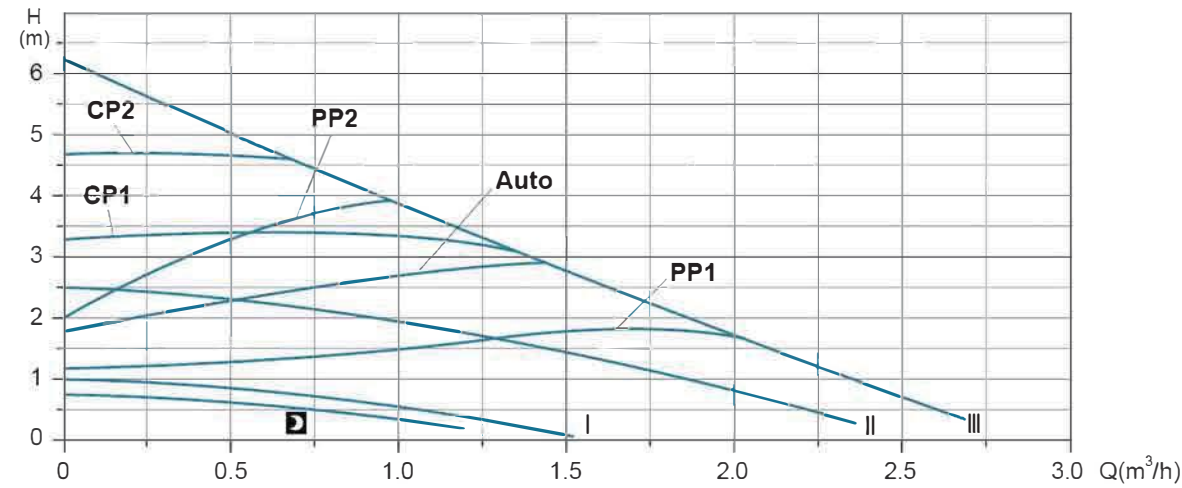

Mode	Pump Feature	Function
Auto	Max. to Min. proportional pressure curve	The auto adapt function enables the pump to control the performance to within a defined performance range. i.e. adjusting the pump performance to the size of the system and the variations in load over time. In this mode, the pump is set to proportional-pressure control.
PP1	Min. Proportion pressure curve	The duty point of the pump will move up or down on the lowest proportional pressure curve, depending on the heat demand in the system. The pressure is reduce at falling of heat demand and increased at demand rising.
PP2	Max. Proportion pressure curve	The duty point of the pump will move up or down on the highest proportional pressure curve, depending on the heat demand in the system. The pressure is reduce at falling of heat demand and increased at demand rising.
CP1	Max. constant pressure curve	The duty point of the pump will move out or in on the highest constant-pressure curve, depending on the heat demand in the system. The pressure is kept constant, irrespective of the heat demand.
CP2	Min. constant pressure curve	The duty point of the pump will move out or in on the lowest constant-pressure curve, depending on the heat demand in the system. The pressure is kept constant, irrespective of the heat demand.
III	Speed III	In speed III, the pump is set to run on the max. curve under all operating conditions. Quick venting of the pump can be obtained by setting the pump to speed III for a short period.
II	Speed II	In speed II, the pump is set to run on the intermediate curve under all operating conditions.
I	Speed I	In speed I, the pump is set to run on the min. curve under all operating conditions.
☐	Night mode	The pump changes to automatic night setback, i.e. minimum performance and power consumption, provided that certain conditions are met.

Technical Data

Model	Voltage /Frequency (V/Hz)	Max.Flow (m³/h)	Max.Head (m)	Power (W)	Inlet/Outlet	Pipe Size (inch)	EEl	G.W. (kg)	Packing Size (mm)
ARP15-40/130	220-240/50	2	4.1	22	Φ15	G1×G1	≤0.23	2.26	154×143×153
ARP15-50/130	220-240/50	2.3	5.2	32	Φ15	G1×G1	≤0.23	2.26	154×143×153
ARP15-60/130	220-240/50	2.6	6.2	45	Φ15	G1×G1	≤0.23	2.26	154×143×153
ARP20-40/130	220-240/50	2	4	22	Φ20	G1.25×G1.25	≤0.23	2.33	154×143×153
ARP20-50/130	220-240/50	2.3	5.1	32	Φ20	G1.25×G1.25	≤0.23	2.33	154×143×153
ARP20-60/130	220-240/50	2.6	6.1	45	Φ20	G1.25×G1.25	≤0.23	2.33	154×143×153
ARP25-40/130	220-240/50	2.1	4	22	Φ25	G1.5×G1.5	≤0.23	2.39	154×143×153
ARP25-40/180	220-240/50	2	4	22	Φ25	G1.5×G1.5	≤0.23	2.56	198×143×160
ARP25-50/130	220-240/50	2.3	5	32	Φ25	G1.5×G1.5	≤0.23	2.39	154×143×153
ARP25-50/180	220-240/50	2.3	5	32	Φ25	G1.5×G1.5	≤0.23	2.56	198×143×160
ARP25-60/130	220-240/50	2.4	6.1	45	Φ25	G1.5×G1.5	≤0.23	2.39	154×143×153
ARP25-60/180	220-240/50	2.7	6	45	Φ25	G1.5×G1.5	≤0.23	2.56	198×143×160
ARP32-40/180	220-240/50	2.2	4	22	Φ32	G2×G2	≤0.23	2.75	198×143×160
ARP32-50/180	220-240/50	2.5	5.1	32	Φ32	G2×G2	≤0.23	2.75	198×143×160
ARP32-60/180	220-240/50	2.8	6.1	45	Φ32	G2×G2	≤0.23	2.75	198×143×160

Performance Curve

Explain: ARPXX-40 curves ( Q-H, Q-P1 ) applies to the following models:  
ARP15-40/130, ARP20-40/130, ARP25-40/130, ARP25-40/180, ARP32-40/180

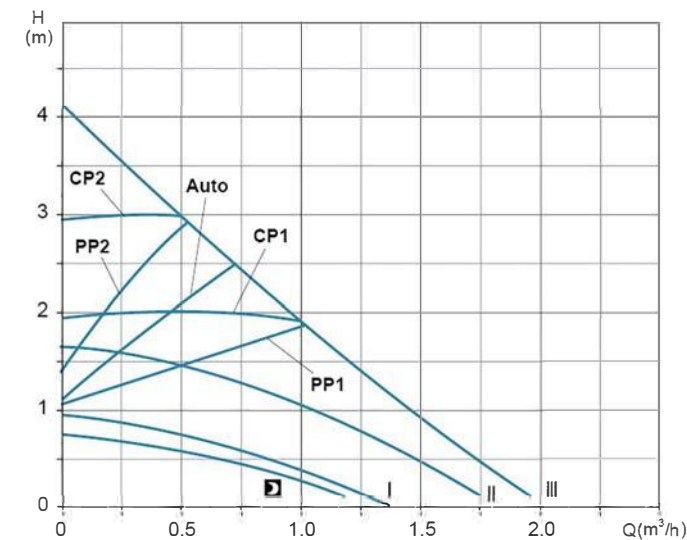

ARPXX-40 Q-H

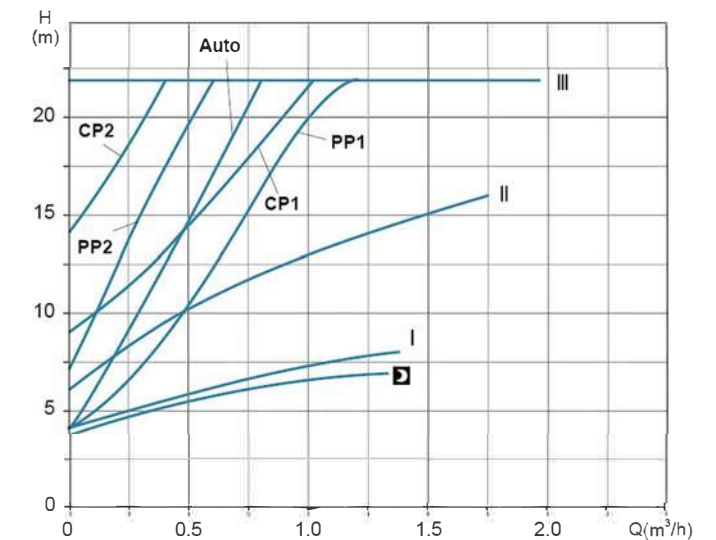

ARPXX-40 Q-P1

### Performance Curve

**Explain:** ARPXX-50 curves ( Q-H, Q-P1 ) applies to the following models:

ARP15-50/130, ARP20-50/130, ARP25-50/130, ARP25-50/180, ARP32-50/180

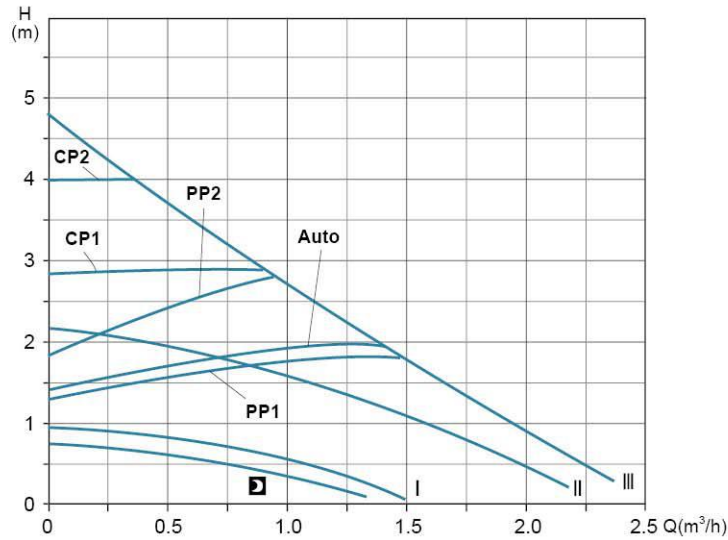

ARPXX-50 Q-H

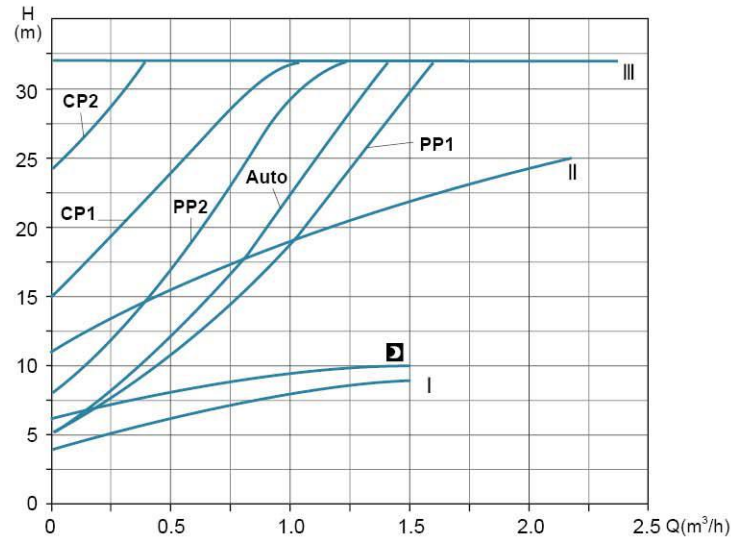

ARPXX-50 Q-P1

**Explain:** ARPXX-60 curves ( Q-H, Q-P1 ) applies to the following models:

ARP15-60/130, ARP20-60/130, ARP25-60/130, ARP25-60/180, ARP32-60/180

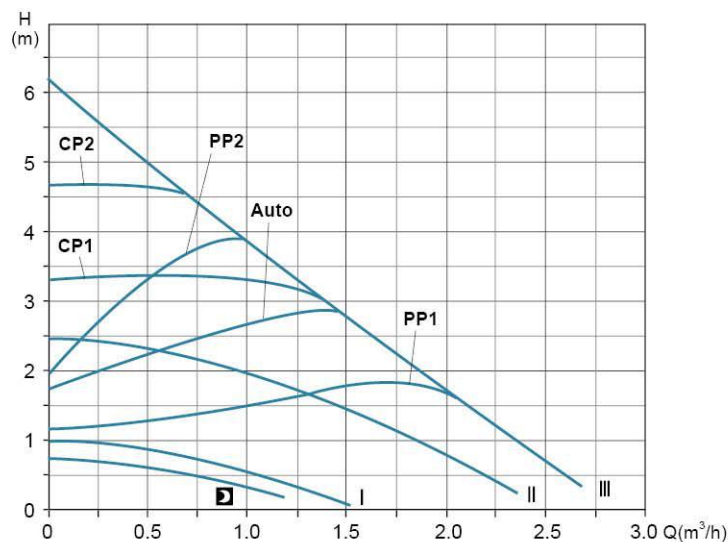

ARPXX-60 Q-H

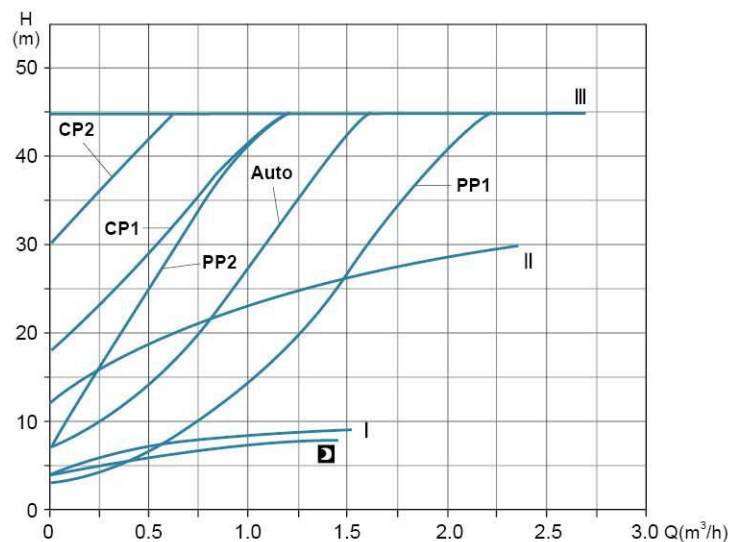

ARPXX-60 Q-P1

### Dimension

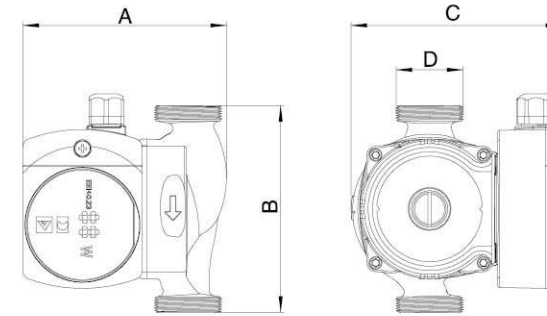

Model	A (mm)	B (mm)	C (mm)	D
ARP15-40/130	130	130	135	G1
ARP15-50/130	130	130	135	G1
ARP15-60/130	130	130	135	G1
ARP20-40/130	130	130	135	G1.25
ARP20-50/130	130	130	135	G1.25
ARP20-60/130	130	130	135	G1.25
ARP25-40/130	130	130	135	G1.5
ARP25-50/130	130	130	135	G1.5
ARP25-60/130	130	130	135	G1.5
ARP25-40/180	130	180	135	G1.5
ARP25-50/180	130	180	135	G1.5
ARP25-60/180	130	180	135	G1.5
ARP32-40/180	135	180	135	G2
ARP32-50/180	135	180	135	G2
ARP32-60/180	135	180	135	G2

### Materials Table

No.	Part	Material
1	Pump body	HT200/AISI304
2	Pump body inset	06Cr19Ni10
3	Body gasket	Silicon rubber
4	Impeller	PPO
5	locking	06Cr19Ni10
6	Check ball	Silicon rubber
7	Pump support cover	
8	Thrust bearing	Graphite
9	Thrust bearing rubber mat	Silicon rubber
10	Thrust bearing adjusting mat	PPO-GF30
11	Rotor	
12	Back bearing adjusting mat	PPO-GF30
13	Can brg asm	
14		
15	Drain plug	DZR
16	Can brg asm seal	Silicon rubber
17	Motor stator with winding	
18	Housing	ADC12
19		
20		
21		
22	Cable outlet nut	PA6-GF20
23		
24		
25	Terminal cover	
26	Terminal box	
27		

